

Switch Amplifier

KCD2-SR-Ex2-AB

- 2-channel isolated barrier
- 24 V DC supply (Power Rail)
- Dry contact or NAMUR inputs
- Relay contact output
- Line fault detection (LFD)
- Housing width 12.5 mm
- Up to SIL 2 (SC 3) acc. to IEC/EN 61508



Function

This isolated barrier is used for intrinsic safety applications. The device transfers digital signals from NAMUR sensors or dry contacts from the hazardous area to the non-hazardous area. The proximity sensor or the mechanical contact controls the control side load for a relay contact output. The device output changes the state when the input signal changes the state. Via switches the mode of operation can be reversed and the line fault detection can be switched off. During a fault condition, the relay reverts to its de-energized state and the LEDs indicate the fault according to NAMUR NE 44. If the device is operated via Power Rail, additionally a collective error message is available. Due to its compact housing design and low heat dissipation, this device is useful for detecting positions, end stops, and switching states in space-critical applications.

Connection

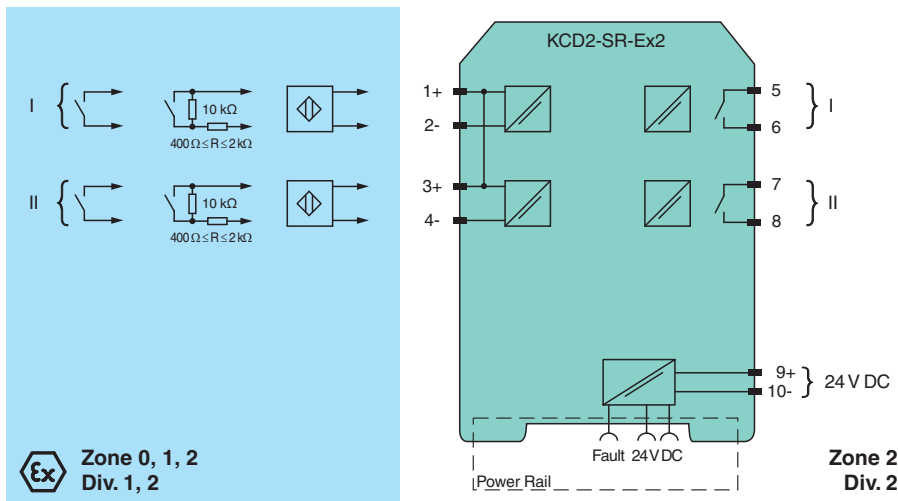

Technical Data

General specifications	
Signal type	Digital Input
Functional safety related parameters	
Safety Integrity Level (SIL)	SIL 2
Systematic capability (SC)	SC 3
Supply	
Connection	Power Rail or terminals 9+, 10-
Rated voltage	U_r 19 ... 30 V DC
Ripple	≤ 10 %
Rated current	I_r ≤ 46 mA
Power dissipation	≤ 900 mW

Release date: 2023-01-03 Date of issue: 2023-01-03 Filename: 70112155_eng.pdf

Refer to "General Notes Relating to Pepperl+Fuchs Product Information".

Pepperl+Fuchs Group
www.pepperl-fuchs.com

USA: +1 330 486 0002
pa-info@us.pepperl-fuchs.com

Germany: +49 621 776 2222
pa-info@de.pepperl-fuchs.com

Singapore: +65 6779 9091
pa-info@sg.pepperl-fuchs.com

PEPPERL+FUCHS

Technical Data

Power consumption	≤ 900 mW
Input	
Connection side	field side
Connection	terminals 1+, 2-; 3+, 4-
Rated values	acc. to EN 60947-5-6 (NAMUR)
Open circuit voltage/short-circuit current	approx. 8 V DC / approx. 8 mA
Switching point/switching hysteresis	1.2 ... 2.1 mA / approx. 0.2 mA
Line fault detection	breakage $I \leq 0.1$ mA , short-circuit $I \geq 6.5$ mA
Pulse/Pause ratio	min. 20 ms / min. 20 ms
Output	
Connection side	control side
Connection	terminals 5, 6; 7, 8
Output I	signal ; relay
Output II	signal ; relay
Contact loading	250 V AC/2 A/cos $\phi > 0.75$; 126.5 V AC/4 A/cos $\phi > 0.75$; 30 V DC/2 A resistive load
Minimum switch current	2 mA / 24 V DC
Energized/De-energized delay	≤ 20 ms / ≤ 20 ms
Mechanical life	10 ⁷ switching cycles
Transfer characteristics	
Switching frequency	≤ 10 Hz
Galvanic isolation	
Input/Output	reinforced insulation according to IEC/EN 61010-1, rated insulation voltage 300 V _{eff}
Input/power supply	reinforced insulation according to IEC/EN 61010-1, rated insulation voltage 300 V _{eff}
Output/power supply	reinforced insulation according to IEC/EN 61010-1, rated insulation voltage 300 V _{eff}
Output/Output	reinforced insulation according to IEC/EN 61010-1, rated insulation voltage 300 V _{eff}
Indicators/settings	
Display elements	LEDs
Control elements	DIP switch
Configuration	via DIP switches
Labeling	space for labeling at the front
Directive conformity	
Electromagnetic compatibility	
Directive 2014/30/EU	EN 61326-1:2013 (industrial locations)
Low voltage	
Directive 2014/35/EU	EN 61010-1:2010+A1:2019+A1:2019/AC:2019
Conformity	
Electromagnetic compatibility	NE 21:2017 , EN 61326-3-1:2017 , EN IEC 61326-3-2:2018
Degree of protection	IEC 60529:1989+A1:1999+A2:2013
Functional safety	IEC/EN 61508:2010
Input	EN 60947-5-6:2000
Ambient conditions	
Ambient temperature	-40 ... 70 °C (-40 ... 158 °F)
Mechanical specifications	
Degree of protection	IP20
Connection	screw terminals
Mass	approx. 100 g
Dimensions	12.5 x 119 x 114 mm (0.5 x 4.7 x 4.5 inch) (W x H x D) , housing type A2
Mounting	on 35 mm DIN mounting rail acc. to EN 60715:2001
Data for application in connection with hazardous areas	
EU-type examination certificate	BASEEFA 06 ATEX 0092 X
Marking	Ⓢ II 3(1)G Ex ec nC [ia Ga] IIC T4 Gc , Ⓢ II (1)D [Ex ia Da] IIIC , Ⓢ I (M1) [Ex ia Ma] I
Input	Ex ia
Voltage	U _o 10.5 V

Release date: 2023-01-03 Date of issue: 2023-01-03 Filename: 70112155_eng.pdf

Refer to "General Notes Relating to Pepperl+Fuchs Product Information".

Pepperl+Fuchs Group
www.pepperl-fuchs.comUSA: +1 330 486 0002
pa-info@us.pepperl-fuchs.comGermany: +49 621 776 2222
pa-info@de.pepperl-fuchs.comSingapore: +65 6779 9091
pa-info@sg.pepperl-fuchs.com

PEPPERL+FUCHS

Technical Data

Current	I_o	13 mA
Power	P_o	34 mW (linear characteristic)
Supply		
Maximum safe voltage	U_m	253 V AC (Attention! U_m is no rated voltage.)
Output		
Contact loading		Zone 2 : 50 V AC/2 A/cos $\phi > 0.75$; 30 V DC/2 A resistive load
Maximum safe voltage	U_m	253 V AC (Attention! The rated voltage can be lower.)
Fault indication output		
Maximum safe voltage	U_m	40 V DC (Attention! U_m is no rated voltage.)
Galvanic isolation		
Input/Output		safe electrical isolation acc. to IEC/EN 60079-11, voltage peak value 375 V
Input/power supply		safe electrical isolation acc. to IEC/EN 60079-11, voltage peak value 375 V
Directive conformity		
Directive 2014/34/EU		EN IEC 60079-0:2018 , EN 60079-7:2015+A1:2018 , EN 60079-11:2012 , EN IEC 60079-15:2019
International approvals		
UL approval		E106378
Control drawing		116-0477 (cULus)
IECEX approval		
IECEX certificate		IECEX BAS 06.0025 X
IECEX marking		Ex ec nC [ia Ga] IIC T4 Gc [Ex ia Da] IIC [Ex ia Ma] I
General information		
Supplementary information		Observe the certificates, declarations of conformity, instruction manuals, and manuals where applicable. For information see www.pepperl-fuchs.com .

Assembly

Front view

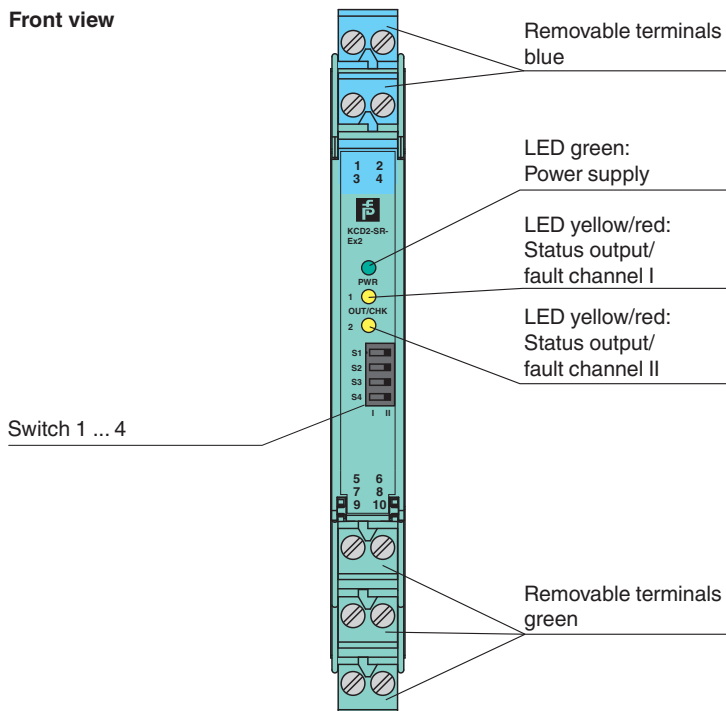

Release date: 2023-01-03 Date of issue: 2023-01-03 Filename: 70112155_eng.pdf

Refer to "General Notes Relating to Pepperl+Fuchs Product Information".





Pepperl+Fuchs Group
www.pepperl-fuchs.com

USA: +1 330 486 0002
pa-info@us.pepperl-fuchs.com





Germany: +49 621 776 2222
pa-info@de.pepperl-fuchs.com

Singapore: +65 6779 9091
pa-info@sg.pepperl-fuchs.com

Matching System Components

	KFD2-EB2	Power Feed Module
	UPR-03-AB	Universal Power Rail with end caps and cover, 3 conductors, length: 2 m
	UPR-03-S-AB	Universal Power Rail with end caps and cover, 3 conductors, length: 0.8 m
	K-DUCT-BU	Profile rail, wiring comb field side, blue
	K-DUCT-BU-UPR-03	Profile rail with UPR-03- * insert, 3 conductors, wiring comb field side, blue

Accessories

	F-NR3-Ex1	NAMUR Resistor Network
	KC-ST-5GN	Terminal block for KC modules, 2-pin screw terminal, green
	KC-ST-5BU	Terminal block for KC modules, 2-pin screw terminal, blue
	KF-CP	Red coding pins, packaging unit: 20 x 6

Configuration

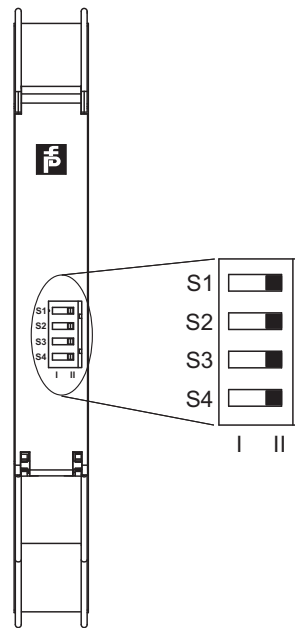

Switch position

S	Function		Position
1	Mode of operation Output I (relay) energized	with high input current	I
		with low input current	II
2	Mode of operation Output II (relay) energized	with high input current	I
		with low input current	II
3	Line fault detection Input I	ON	I
		OFF	II
4	Line fault detection Input II	ON	I
		OFF	II

Operating status

Control circuit	Input signal
Initiator high impedance/contact opened	low input current
Initiator low impedance/contact closed	high input current
Lead breakage, lead short-circuit	Line fault

Factory settings: switch 1, 2, 3 and 4 in position I

Characteristic Curve

Maximum switching power of output contacts

Release date: 2023-01-03 Date of issue: 2023-01-03 Filename: 70112155_eng.pdf

Refer to "General Notes Relating to Pepperl+Fuchs Product Information".

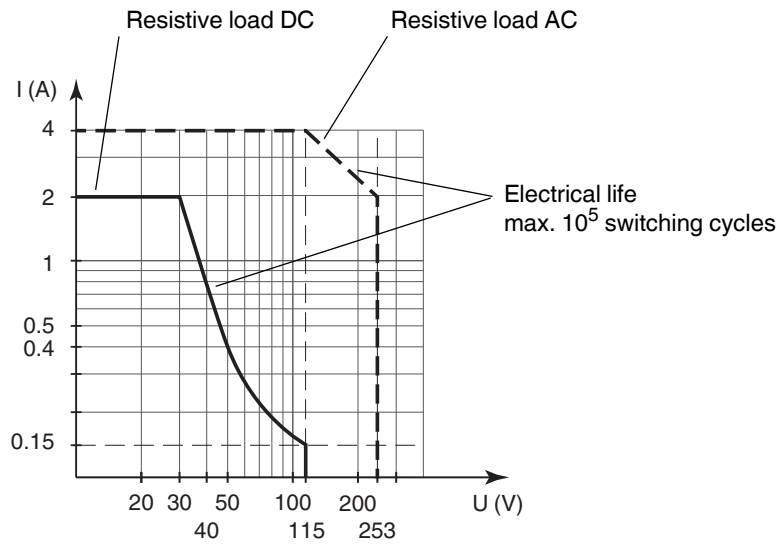

The maximum number of switching cycles is depending on the electrical load and may be higher when reduced currents and voltages are applied.

Release date: 2023-01-03 Date of issue: 2023-01-03 Filename: 70112155_eng.pdf