



Switch Amplifier

WE77/Ex-1 230V

- 1-channel
- Control circuit EEx ia IIC
- 230 V AC supply voltage
- Reversible mode of operation
- Lead breakage (LB) monitoring
- 1 relay contact output (change-over contact)



Function

The device transfers digital signals into hazardous areas. Sensors per EN 60947-5-6 (NAMUR) or mechanical contacts may be used as transmitters. The control circuit is monitored for lead breakage (LB).

Connection

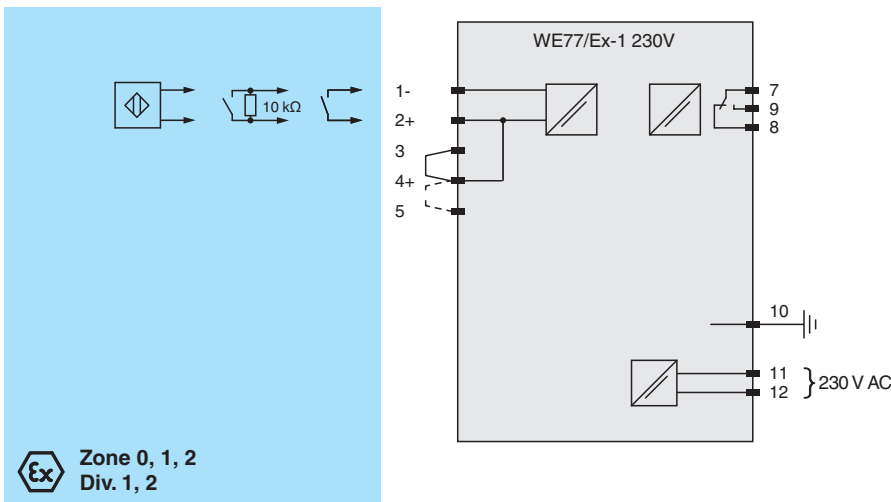

Ex Zone 0, 1, 2
Div. 1, 2

Dimensions

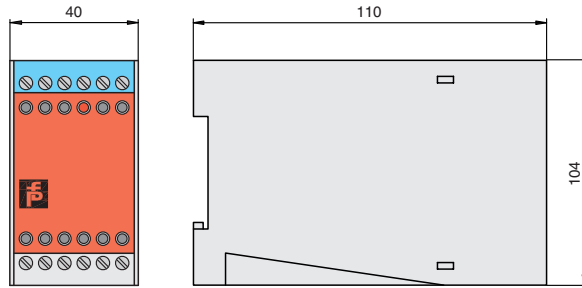

Technical Data

General specifications	
Signal type	Digital Input
Supply	
Connection	terminals 11, 12
Rated voltage	U_r 198 ... 253 V AC ; 45 ... 65 Hz
Power dissipation	1.6 W
Power consumption	approx. 2.3 VA
Input	
Connection side	field side
Connection	terminals 1-, 2+
Rated values	acc. to EN 60947-5-6 (NAMUR), see manual for electrical data
Open circuit voltage/short-circuit current	approx. 8 V DC / approx. 8 mA
Switching point/switching hysteresis	1.2 ... 2.1 mA / approx. 0.2 mA
Pulse/Pause ratio	min. 0.5 ms / min. 0.5 ms
Line fault detection	breakage $I \leq 0.1$ mA
Output	
Connection side	control side
Connection	terminals 7, 8, 9
Output	signal ; relay
Contact loading	253 V AC/2 A/500 VA/cos ϕ min. 0,7; 125 V AC/4 A/500 VA cos ϕ min. 0,7; 40 V DC/2 A/80 W ohmic load
Energized/De-energized delay	approx. 10 ms / approx. 20 ms
Mechanical life	10^7 switching cycles
Transfer characteristics	
Switching frequency	< 10 Hz
Galvanic isolation	
Input/Output	reinforced insulation according to IEC/EN 61010-1, rated insulation voltage 300 V _{eff}
Input/power supply	reinforced insulation according to IEC/EN 61010-1, rated insulation voltage 300 V _{eff}
Output/power supply	basic insulation according to IEC/EN 61010-1, rated insulation voltage 300 V _{eff}
Indicators/settings	
Display elements	LED
Directive conformity	
Electromagnetic compatibility	
Directive 2014/30/EU	EN 61326-1:2013 (industrial locations)
Low voltage	
Directive 2014/35/EU	EN 61010-1:2010

Release date: 2023-01-05 Date of issue: 2023-01-05 Filename: 129197_eng.pdf

Refer to "General Notes Relating to Pepperl+Fuchs Product Information".

Technical Data

Conformity		
Degree of protection		IEC 60529
Ambient conditions		
Ambient temperature		-20 ... 60 °C (-4 ... 140 °F)
Mechanical specifications		
Degree of protection		IP20
Connection		screw terminals
Mass		approx. 390 g
Dimensions		40 x 104 x 110 mm (1.6 x 4.1 x 4.3 inch) (W x H x D) , housing type W1
Data for application in connection with hazardous areas		
EU-type examination certificate		PTB 02 ATEX 2065
Marking		Ⓔ II (1)GD [EEx ia] IIC [circuit(s) in zone 0/1/2]
Input		Ex ia
Voltage	U _o	13.4 V DC
Current	I _o	31 mA
Power	P _o	145 mW (trapezoid characteristic curve)
Supply		
Maximum safe voltage	U _m	253 V AC (Attention! The rated voltage can be lower.)
Output		
Maximum safe voltage	U _m	253 V AC (Attention! The rated voltage can be lower.)
Galvanic isolation		
Input/Output		safe electrical isolation acc. to IEC/EN 60079-11, voltage peak value 375 V
Input/power supply		safe electrical isolation acc. to IEC/EN 60079-11, voltage peak value 375 V
Directive conformity		
Directive 2014/34/EU		EN 60079-0:2012+A11:2013 , EN 60079-11:2012
General information		
Supplementary information		Observe the certificates, declarations of conformity, instruction manuals, and manuals where applicable. For information see www.pepperl-fuchs.com .

Assembly

Front view

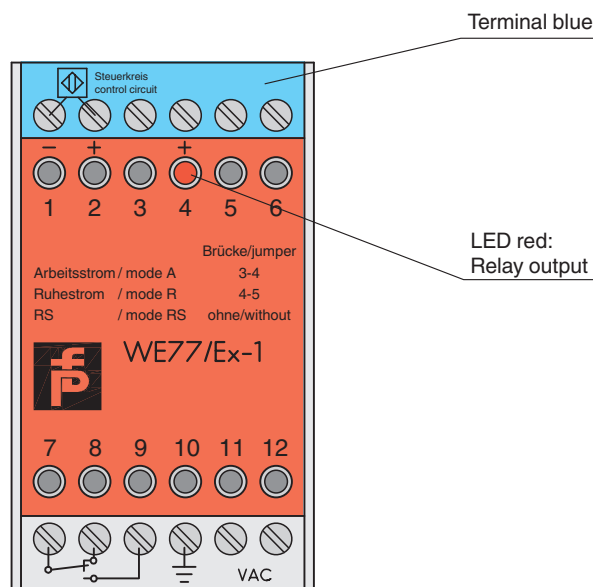

Release date: 2023-01-05 Date of issue: 2023-01-05 Filename: 129197_eng.pdf

Refer to "General Notes Relating to Pepperl+Fuchs Product Information".

Pepperl+Fuchs Group
www.pepperl-fuchs.com

USA: +1 330 486 0002
pa-info@us.pepperl-fuchs.com









Germany: +49 621 776 2222
pa-info@de.pepperl-fuchs.com

Singapore: +65 6779 9091
pa-info@sg.pepperl-fuchs.com









PEPPERL+FUCHS

Configuration

Mode of operation without lead breakage detection

Jumpers	Input	Output
Jumpers between terminals 4 and 5		 Relay energized
	0-Signal	
Jumpers between terminals 4 and 5		 Relay de-energized
	1-Signal	
Jumpers between terminals 3 and 4		 Relay energized
	1-Signal	
Jumpers between terminals 3 and 4		 Relay de-energized
	0-Signal	

Mode of operation with lead breakage detection

Jumpers	Input	Output
Without jumpers		 Relay energized
	0-Signal	
Without jumpers		 Relay de-energized
	1-Signal	
Without jumpers		 Relay de-energized
	0-Signal	
Without jumpers		 Relay de-energized
	1-Signal	

Release date: 2023-01-05 Date of issue: 2023-01-05 Filename: 129197_eng.pdf

Refer to "General Notes Relating to Pepperl+Fuchs Product Information".