

SMART Transmitter Power Supply KFD2-STV4-Ex2-1

- 2-channel isolated barrier
- 24 V DC supply (Power Rail)
- Input 2-wire SMART transmitters
- Output 0/1 V ... 5 V
- Terminals with test points
- Up to SIL 2 acc. to IEC/EN 61508



Function

This isolated barrier is used for intrinsic safety applications. The device supplies 2-wire SMART transmitters in a hazardous area. It transfers the analog input signal to the safe area as an isolated voltage value. Digital signals may be superimposed on the input signal in the hazardous or safe area and are transferred bi-directionally. If the HART communication resistance in the loop is too low, the internal resistance of 250 Ω between terminals 8, 9 and 11, 12 can be used. Test sockets for the connection of HART communicators are integrated into the terminals of the device.

Connection

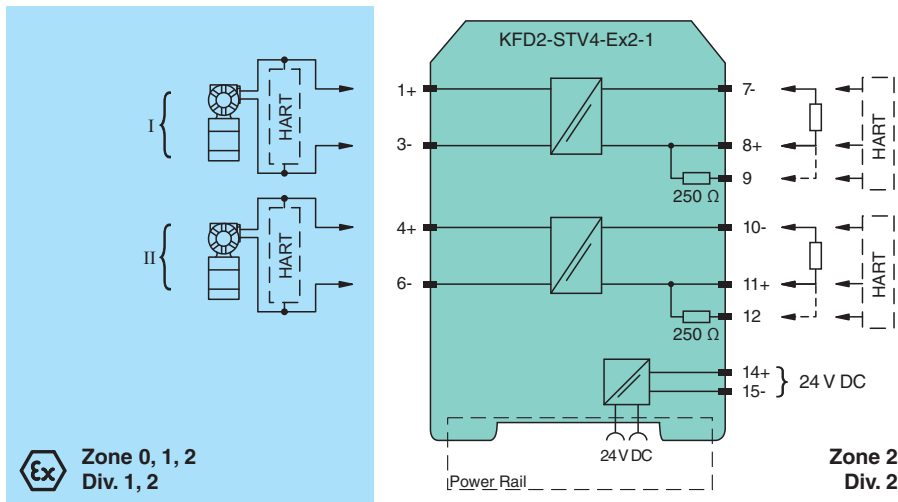

Technical Data

General specifications	
Signal type	Analog input
Functional safety related parameters	
Safety Integrity Level (SIL)	SIL 2
Supply	
Connection	Power Rail or terminals 14+, 15-
Rated voltage	U_r 20 ... 35 V DC
Ripple	within the supply tolerance
Power dissipation	1.8 W
Power consumption	max. 2.7 W

Release date: 2021-12-20 Date of issue: 2021-12-20 Filename: 283726_eng.pdf

Refer to "General Notes Relating to Pepperl+Fuchs Product Information".

Pepperl+Fuchs Group
www.pepperl-fuchs.com

USA: +1 330 486 0002
pa-info@us.pepperl-fuchs.com

Germany: +49 621 776 2222
pa-info@de.pepperl-fuchs.com

Singapore: +65 6779 9091
pa-info@sg.pepperl-fuchs.com

PEPPERL+FUCHS

Technical Data

Input	
Connection side	field side
Connection	terminals 1+, 3-; 4+, 6-
Input signal	0/4 ... 20 mA
Available voltage	≥ 16 V at 20 mA, terminals 1+, 3
Output	
Connection side	control side
Connection	terminals 7-, 8+; 10-, 11+
Load	output resistance: 250 Ω
Output signal	0/1 ... 5 V
Ripple	max. 12.5 mV
Transfer characteristics	
Deviation	at 20 °C (68 °F), 0/1 ... 5 V ≤ 5 mV incl. calibration, linearity, hysteresis, loads and fluctuations of supply voltage
Influence of ambient temperature	≤ 20 ppm/K
Frequency range	field side into the control side: bandwidth with 0.5 V _{pp} signal 0 ... 7.5 kHz (-3 dB) control side into the field side: bandwidth with 0.5 V _{pp} signal 0.3 ... 7.5 kHz (-3 dB)
Rise time	20 μs
Settling time	200 μs
De-energized delay	20 μs
Galvanic isolation	
Output/power supply	functional insulation, rated insulation voltage 50 V AC
Output/Output	functional insulation, rated insulation voltage 50 V AC
Indicators/settings	
Display elements	LED
Labeling	space for labeling at the front
Directive conformity	
Electromagnetic compatibility	
Directive 2014/30/EU	EN 61326-1:2013 (industrial locations)
Conformity	
Electromagnetic compatibility	NE 21:2011
Degree of protection	IEC 60529:2001
Protection against electrical shock	UL 61010-1:2012
Ambient conditions	
Ambient temperature	-20 ... 60 °C (-4 ... 140 °F)
Mechanical specifications	
Degree of protection	IP20
Connection	screw terminals
Mass	approx. 150 g
Dimensions	20 x 124 x 115 mm (0.8 x 4.9 x 4.5 inch) (W x H x D), housing type B2
Mounting	on 35 mm DIN mounting rail acc. to EN 60715:2001
Data for application in connection with hazardous areas	
EU-type examination certificate	BAS 99 ATEX 7025 X
Marking	⊕ II (1)G [Ex ia Ga] IIC, ⊕ II (1)D [Ex ia Da] IIIC, ⊕ I (M1) [Ex ia Ma] I
Input	[Ex ia Ga] IIC, [Ex ia Da] IIIC, [Ex ia Ma] I
Voltage	U _o 25.2 V
Current	I _o 93 mA
Power	P _o 0.586 W
Supply	
Maximum safe voltage	U _m 250 V (Attention! The rated voltage can be lower.)
Certificate	TÜV 99 ATEX 1499 X
Marking	⊕ II 3G Ex nA II T4 [device in zone 2]
Galvanic isolation	
Input/Output	safe electrical isolation acc. to IEC/EN 60079-11, voltage peak value 375 V

Release date: 2021-12-20 Date of issue: 2021-12-20 Filename: 283726_eng.pdf

Refer to "General Notes Relating to Pepperl+Fuchs Product Information".

Pepperl+Fuchs Group
www.pepperl-fuchs.comUSA: +1 330 486 0002
pa-info@us.pepperl-fuchs.comGermany: +49 621 776 2222
pa-info@de.pepperl-fuchs.comSingapore: +65 6779 9091
pa-info@sg.pepperl-fuchs.com

PEPPERL+FUCHS

Technical Data

Input/power supply	safe electrical isolation acc. to IEC/EN 60079-11, voltage peak value 375 V
Directive conformity	
Directive 2014/34/EU	EN 60079-0:2012+A11:2013 , EN 60079-11:2012 , EN 60079-15:2010
International approvals	
UL approval	
Control drawing	116-0428 (cULus)
IECEX approval	
IECEX certificate	IECEX BAS 04.0015X IECEX CML 15.0055X
IECEX marking	[Ex ia Ga] IIC , [Ex ia Da] IIIC , [Ex ia Ma] I Ex nA IIC T4 Gc
General information	
Supplementary information	Observe the certificates, declarations of conformity, instruction manuals, and manuals where applicable. For information see www.pepperl-fuchs.com .

Assembly

Front view

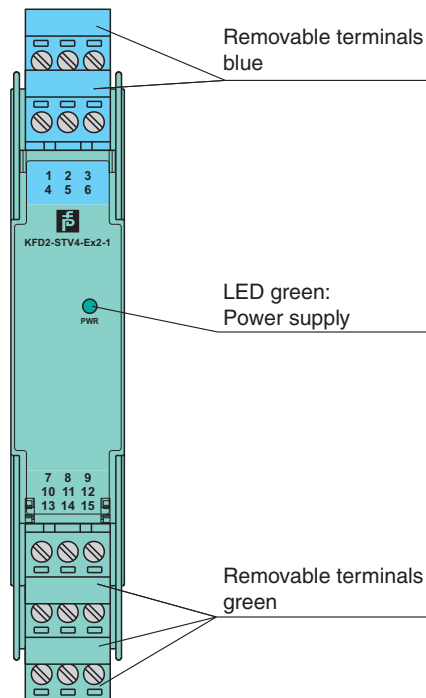

Matching System Components





	KFD2-EB2	Power Feed Module
	UPR-03	Universal Power Rail with end caps and cover, 3 conductors, length: 2 m
	UPR-03-M	Universal Power Rail with end caps and cover, 3 conductors, length: 1,6 m
	UPR-03-S	Universal Power Rail with end caps and cover, 3 conductors, length: 0.8 m
	K-DUCT-BU	Profile rail, wiring comb field side, blue

Release date: 2021-12-20 Date of issue: 2021-12-20 Filename: 283726_eng.pdf

Matching System Components

	K-DUCT-BU-UPR-03	Profile rail with UPR-03- * insert, 3 conductors, wiring comb field side, blue
---	-------------------------	--

Accessories

	KF-STP-5BU	Terminal block for KF modules, 3-pin screw terminal, with test sockets, blue
	KF-STP-5GN	Terminal block for KF modules, 3-pin screw terminal, with test sockets, green
	KF-ST-5GN	Terminal block for KF modules, 3-pin screw terminal, green
	KF-CP	Red coding pins, packaging unit: 20 x 6

Release date: 2021-12-20 Date of issue: 2021-12-20 Filename: 283726_eng.pdf

Application

The device supports the following SMART protocols:

- HART
- BRAIN
- Foxboro