

# Termination Board

## HiCTB32-SDC-24C-SC-RA

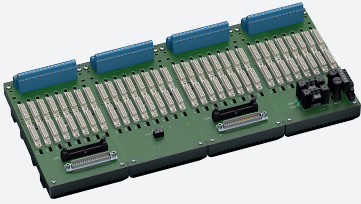

- For 32 modules
- 24 V DC supply
- Supported signal types: DI/DO/AI/TI/AO/UIO
- Hazardous area: screw terminals, blue
- Non-hazardous area: Sub-D connector (male), 37-pin



### Function

The termination board has 32 plugin slots for isolators. Any isolator can be inserted into any slot, enabling a mixture of I/O types on one termination board. The termination board features fixed screw terminals for the field side connection and 37-pin Sub-D connectors for the control side connection along with a HART cordset for interconnection to a separate HART Communication Board. Information about missing supply voltage of the isolators is available for the system as volt-free contact at the redundant power supply terminals. Wiring errors from field side will be reported via the same relay contact, if this function supported by the the isolators. The termination board is supplied with a robust plastic housing as standard. This design permits the fast and reliable installation on 35 mm DIN mounting rail acc. to EN 60715 in the cabinet.

### Connection

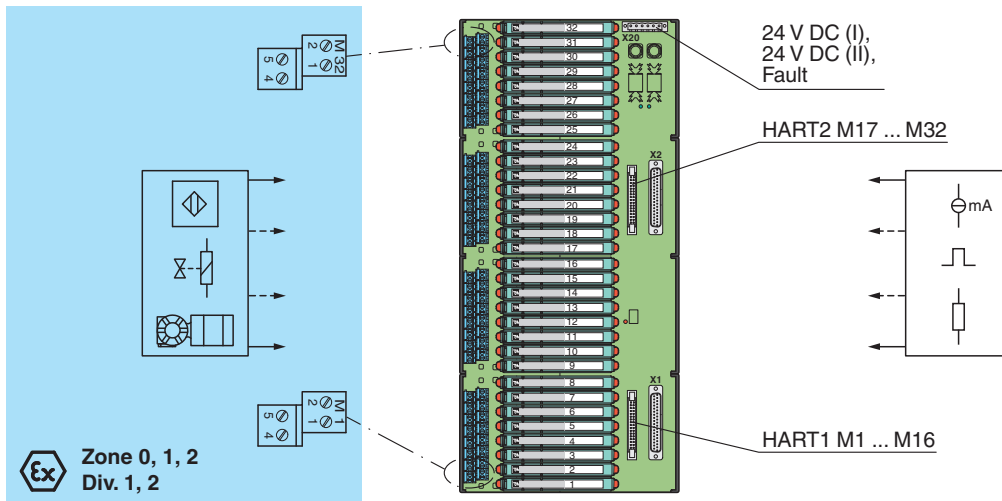

### Technical Data

Supply	
Connection	X20: terminals 3, 5(+); 4, 6(-)
Nominal voltage	24 V DC , in consideration of rated voltage of used isolators
Voltage drop	0.9 V , voltage drop across the series diode on the termination board must be considered
Ripple	≤ 10 %
Fusing	4 A , in each case for 32 modules
Power dissipation	≤ 500 mW , without modules
Reverse polarity protection	yes
Redundancy	

Release date: 2023-02-20 Date of issue: 2023-02-20 Filename: 260223\_eng.pdf

Refer to "General Notes Relating to Pepperl+Fuchs Product Information".

Pepperl+Fuchs Group  
www.pepperl-fuchs.com

USA: +1 330 486 0002  
pa-info@us.pepperl-fuchs.com

Germany: +49 621 776 2222  
pa-info@de.pepperl-fuchs.com

Singapore: +65 6779 9091  
pa-info@sg.pepperl-fuchs.com

**PEPPERL+FUCHS**

## Technical Data

Supply	Redundancy available. The supply for the isolators is decoupled, monitored and fused.
<b>Fault indication output</b>	
Connection	X20: terminals 1, 2
Output type	volt-free contact
Switch behaviour	no fault: relay contact closed power supply fault: relay contact open module fault: relay contact open
Contact loading	30 V DC, 1 A
<b>Indicators/settings</b>	
Display elements	LED PWR1 (termination board power supply), green LED LED PWR2 (termination board power supply), green LED LED FAULT (fault indication), red LED - LED lits: module fault - LED flashes: power supply fault
<b>Directive conformity</b>	
Electromagnetic compatibility	
Directive 2014/30/EU	EN 61326-1:2013 (industrial locations)
<b>Conformity</b>	
Electromagnetic compatibility	NE 21:2017 For further information see system description.
Degree of protection	IEC 60529:2001
<b>Ambient conditions</b>	
Ambient temperature	-20 ... 60 °C (-4 ... 140 °F)
Storage temperature	-40 ... 70 °C (-40 ... 158 °F)
<b>Mechanical specifications</b>	
Degree of protection	IP20
Connection	
Field side	explosion hazardous area: 4 screw terminals per module , blue
Control side	non-explosion hazardous area: 2 37-pin Sub-D connector
Supply	pluggable screw terminals , black
Fault output	pluggable screw terminals , black
Core cross section	screw terminals: 0.25 ... 1.5 mm <sup>2</sup> (24 ... 12 AWG)
Material	housing: polycarbonate, 10 % glass fiber reinforced
Mass	approx. 1430 g
Dimensions	432 x 200 x 163 mm (17 x 7.9 x 6.42 inch) (W x H x D) , depth including module assembly
Mounting	on 35 mm DIN mounting rail acc. to EN 60715:2001
<b>Data for application in connection with hazardous areas</b>	
EU-type examination certificate	CESI 06 ATEX 022
Marking	⊕ II (1)G [Ex ia Ga] IIC ⊕ II (1)D [Ex ia Da] IIIC ⊕ I (M1) [Ex ia Ma] I
Non-hazardous area	
Maximum safe voltage	250 V (Attention! U <sub>m</sub> is no rated voltage.)
Galvanic isolation	
Field circuit/control circuit	safe electrical isolation acc. to IEC/EN 60079-11, voltage peak value 375 V
Directive conformity	
Directive 2014/34/EU	EN IEC 60079-0:2018+AC:2020 , EN 60079-11:2012 , EN 50303:2000
<b>International approvals</b>	
UL approval	E106378
Control drawing	116-0327
IECEx approval	
IECEx certificate	IECEx CES 06.0003
IECEx marking	[Ex ia Ga] IIC [Ex ia Da] IIIC [Ex ia Ma] I
<b>General information</b>	

Release date: 2023-02-20 Date of issue: 2023-02-20 Filename: 260223\_eng.pdf

Refer to "General Notes Relating to Pepperl+Fuchs Product Information".

Pepperl+Fuchs Group  
www.pepperl-fuchs.comUSA: +1 330 486 0002  
pa-info@us.pepperl-fuchs.comGermany: +49 621 776 2222  
pa-info@de.pepperl-fuchs.comSingapore: +65 6779 9091  
pa-info@sg.pepperl-fuchs.com









**PEPPERL+FUCHS**

## Technical Data

Supplementary information

Observe the certificates, declarations of conformity, instruction manuals, and manuals where applicable. For information see [www.pepperl-fuchs.com](http://www.pepperl-fuchs.com).

## Accessories

	<b>HiATB01-HART-2X16</b>	HART Communication Board
	<b>HiDMux2700</b>	HART Multiplexer Master
	<b>H-CJC-Pt100</b>	Resistance thermometer for cold junction compensation for H-System termination boards
	<b>HiACA-UNI-FLK34-FLK34-0M5</b>	HART Connection Cable, length: 0,5 m
	<b>HiACA-UNI-FLK34-FLK34-1M0</b>	HART Connection Cable, length: 1 m
	<b>HiACA-UNI-FLK34-FLK34-2M0</b>	HART Connection Cable, length: 2 m
	<b>HiACA-UNI-FLK34-FLK34-3M0</b>	HART Connection Cable, length: 3 m
	<b>HiACA-UNI-FLK34-FLK34-6M0</b>	HART Connection Cable, length: 6 m
	<b>HiALC-HICTB-SET-108</b>	Label carrier for HiC termination boards

**Connection**

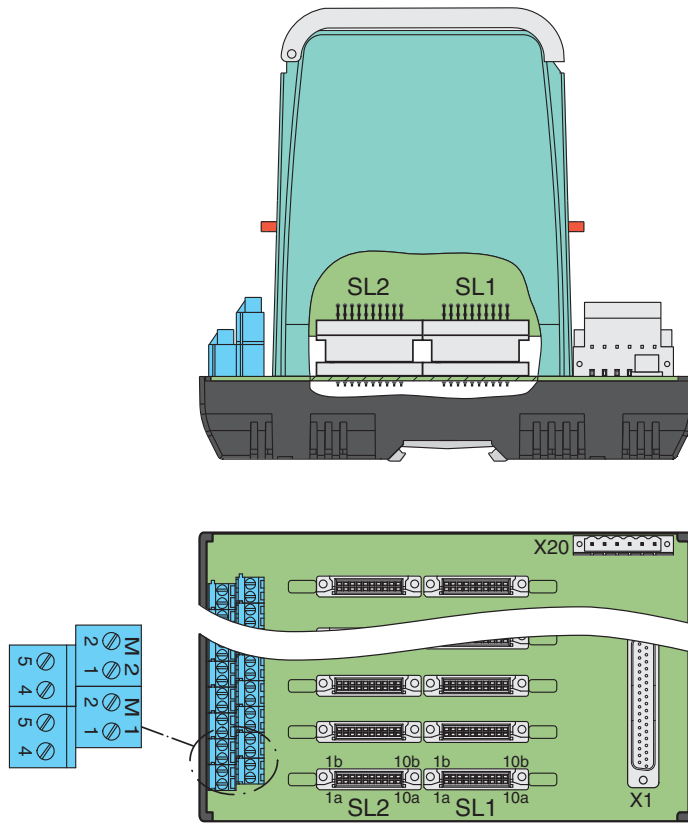

Insert the isolated barrier on the Termination Board. This closes the signal circuit between field side and control side. Connect field devices and controller to the terminals or connecting plugs of the Termination Board. For pin assignment between terminals, connecting plugs and connectors SL1/SL2, see drawing "Connection diagram" or the corresponding pin-out table on [www.pepperl-fuchs.com](http://www.pepperl-fuchs.com).



For exact pin assignment for fieldside and control side, see the documentation of the isolated barrier.

**Application**

**Typical loop**

Release date: 2023-02-20 Date of issue: 2023-02-20 Filename: 260223\_eng.pdf

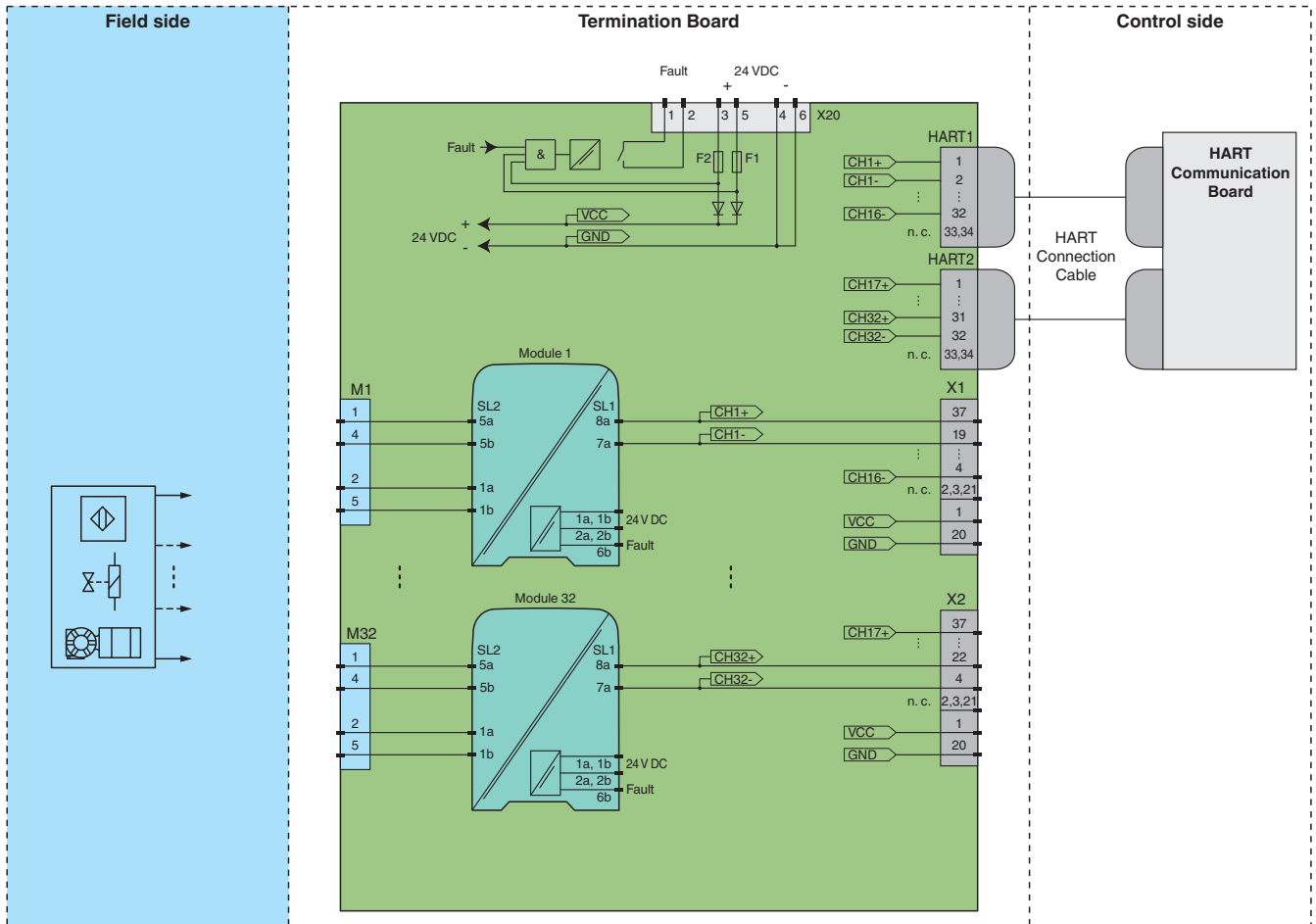

For exact pin assignment for connection to field side and control side, see the documentation of the isolated barrier.



The pin-out configuration has to be observed. For information see corresponding pin-out table on [www.pepperl-fuchs.com](http://www.pepperl-fuchs.com).