

Termination Board

HiCTB16-TRI-AIIS-EL-PL

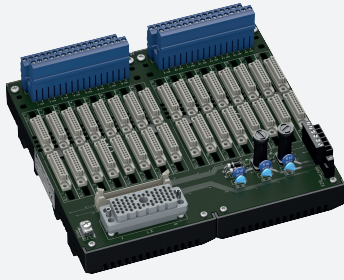

- System board for Schneider Electric, Tricon series by Triconex
- TAN48 approval
- For 32-channel (16+16) AI cards 3700A, and 3721
- For 16 modules
- Recommended modules: HiC2025(A) (AI)
- 24 V DC supply
- Hazardous area: pluggable screw terminals, blue
- Non-hazardous area: ELCO socket, 56-pin



Function

The function of the termination board and the connector pinout is exactly fitted to the requirements of Triconex system. The termination board has a fault bus (Fault) that is available at the redundant terminals. Power supply faults and module faults are indicated via this fault bus. The fault signals of several termination boards can be connected together and can be monitored by an optional fault indication board. The fault signals are then available to the control system as a volt-free contact. The termination board is supplied with a robust plastic housing. This design permits the fast and reliable installation on 35 mm DIN mounting rail according to EN 60715 in the switch cabinet.

Application

- Triconex card Tricon:
- Termination board 1 and cable 1: channel 1 to 16
 - Termination board 2 and cable 2: channel 17 to 32

Connection

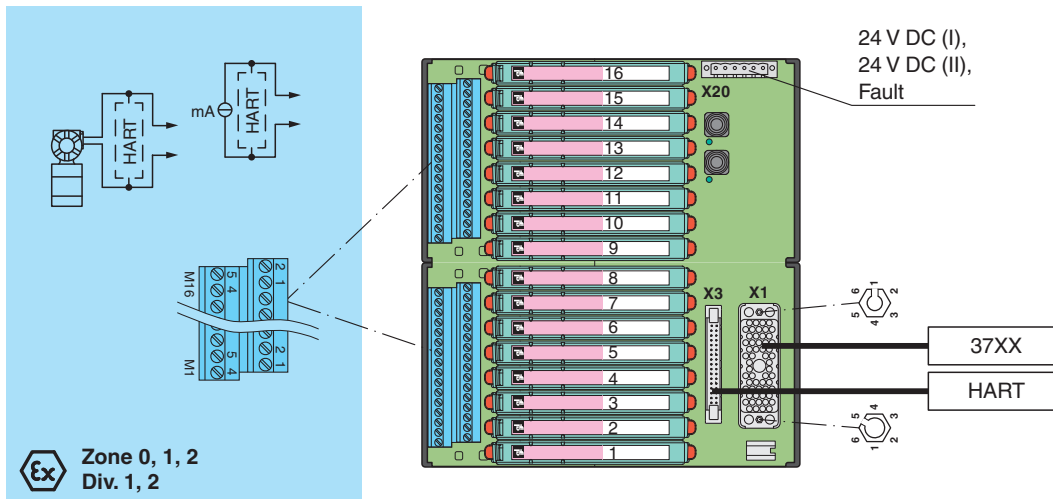

Technical Data

Supply	
Connection	X20: terminals 3, 5(+); 4, 6(-)
Nominal voltage	24 V DC , in consideration of rated voltage of used isolators
Voltage drop	0.9 V , voltage drop across the series diode on the termination board must be considered
Ripple	≤ 10 %
Fusing	4 A , in each case for 16 modules

Release date: 2023-02-20 Date of issue: 2023-02-20 Filename: 215712_eng.pdf

Refer to "General Notes Relating to Pepperl+Fuchs Product Information".

Pepperl+Fuchs Group
www.pepperl-fuchs.com

USA: +1 330 486 0002
pa-info@us.pepperl-fuchs.com

Germany: +49 621 776 2222
pa-info@de.pepperl-fuchs.com

Singapore: +65 6779 9091
pa-info@sg.pepperl-fuchs.com

PEPPERL+FUCHS

Technical Data

Power dissipation	≤ 500 mW , without modules
Reverse polarity protection	yes
Redundancy	
Supply	Redundancy available. The supply for the isolators is decoupled, monitored and fused.
Fault indication output	
Connection	fault bus (Fault) : X20: terminals 1, 2
Output type	volt-free contact
Switch behaviour	fault bus (Fault) - no fault: relay contact of the fault indication board closed - power supply fault: relay contact of the fault indication board open - module fault: relay contact of the fault indication board open
Contact loading	fault bus (Fault) : 30 V DC , 1 A , see fault indication board
Indicators/settings	
Display elements	LED PWR1 (termination board power supply), green LED LED PWR2 (termination board power supply), green LED
Directive conformity	
Electromagnetic compatibility	
Directive 2014/30/EU	EN 61326-1:2013 (industrial locations)
Conformity	
Electromagnetic compatibility	NE 21:2017 For further information see system description.
Degree of protection	IEC 60529:2001
Ambient conditions	
Ambient temperature	-20 ... 60 °C (-4 ... 140 °F)
Storage temperature	-40 ... 70 °C (-40 ... 158 °F)
Mechanical specifications	
Degree of protection	IP20
Connection	
Field side	explosion hazardous area: pluggable screw terminals , blue
Control side	non-explosion hazardous area: ELCO socket, 56-pin
Supply	pluggable screw terminals , black
Fault output	pluggable screw terminals , black
Core cross section	screw terminals: 0.2 ... 2.5 mm ² (24 ... 12 AWG)
Material	housing: polycarbonate, 10 % glass fiber reinforced
Mass	approx. 780 g
Dimensions	216 x 200 x 163 mm (8.5 x 7.9 x 6.42 inch) (W x H x D) , depth including module assembly
Mounting	on 35 mm DIN mounting rail acc. to EN 60715:2001
Data for application in connection with hazardous areas	
EU-type examination certificate	CESI 06 ATEX 022
Marking	⊕ II (1)G [Ex ia Ga] IIC ⊕ II (1)D [Ex ia Da] IIIC ⊕ I (M1) [Ex ia Ma] I
Non-hazardous area	
Maximum safe voltage	250 V (Attention! U _m is no rated voltage.)
Galvanic isolation	
Field circuit/control circuit	safe electrical isolation acc. to IEC/EN 60079-11, voltage peak value 375 V
Directive conformity	
Directive 2014/34/EU	EN IEC 60079-0:2018+AC:2020 , EN 60079-11:2012 , EN 50303:2000
International approvals	
UL approval	E106378
Control drawing	116-0327
IECEx approval	
IECEx certificate	IECEx CES 06.0003

Release date: 2023-02-20 Date of issue: 2023-02-20 Filename: 215712_eng.pdf

Refer to "General Notes Relating to Pepperl+Fuchs Product Information".









Pepperl+Fuchs Group
www.pepperl-fuchs.comUSA: +1 330 486 0002
pa-info@us.pepperl-fuchs.comGermany: +49 621 776 2222
pa-info@de.pepperl-fuchs.comSingapore: +65 6779 9091
pa-info@sg.pepperl-fuchs.com

PEPPERL+FUCHS

Technical Data

IECEX marking	[Ex ia Ga] IIC [Ex ia Da] IIC [Ex ia Ma] I
General information	
Supplementary information	Observe the certificates, declarations of conformity, instruction manuals, and manuals where applicable. For information see www.pepperl-fuchs.com .

Accessories

	HiATB01-HART-2X16	HART Communication Board
	HiDMux2700	HART Multiplexer Master
	HiACA-UNI-FLK34-FLK34-0M5	HART Connection Cable, length: 0,5 m
	HiACA-UNI-FLK34-FLK34-1M0	HART Connection Cable, length: 1 m
	HiACA-UNI-FLK34-FLK34-2M0	HART Connection Cable, length: 2 m
	HiACA-UNI-FLK34-FLK34-3M0	HART Connection Cable, length: 3 m
	HiACA-UNI-FLK34-FLK34-6M0	HART Connection Cable, length: 6 m
	HiALC-HiCTB-SET-108	Label carrier for HiC termination boards

Application

Typical circuit

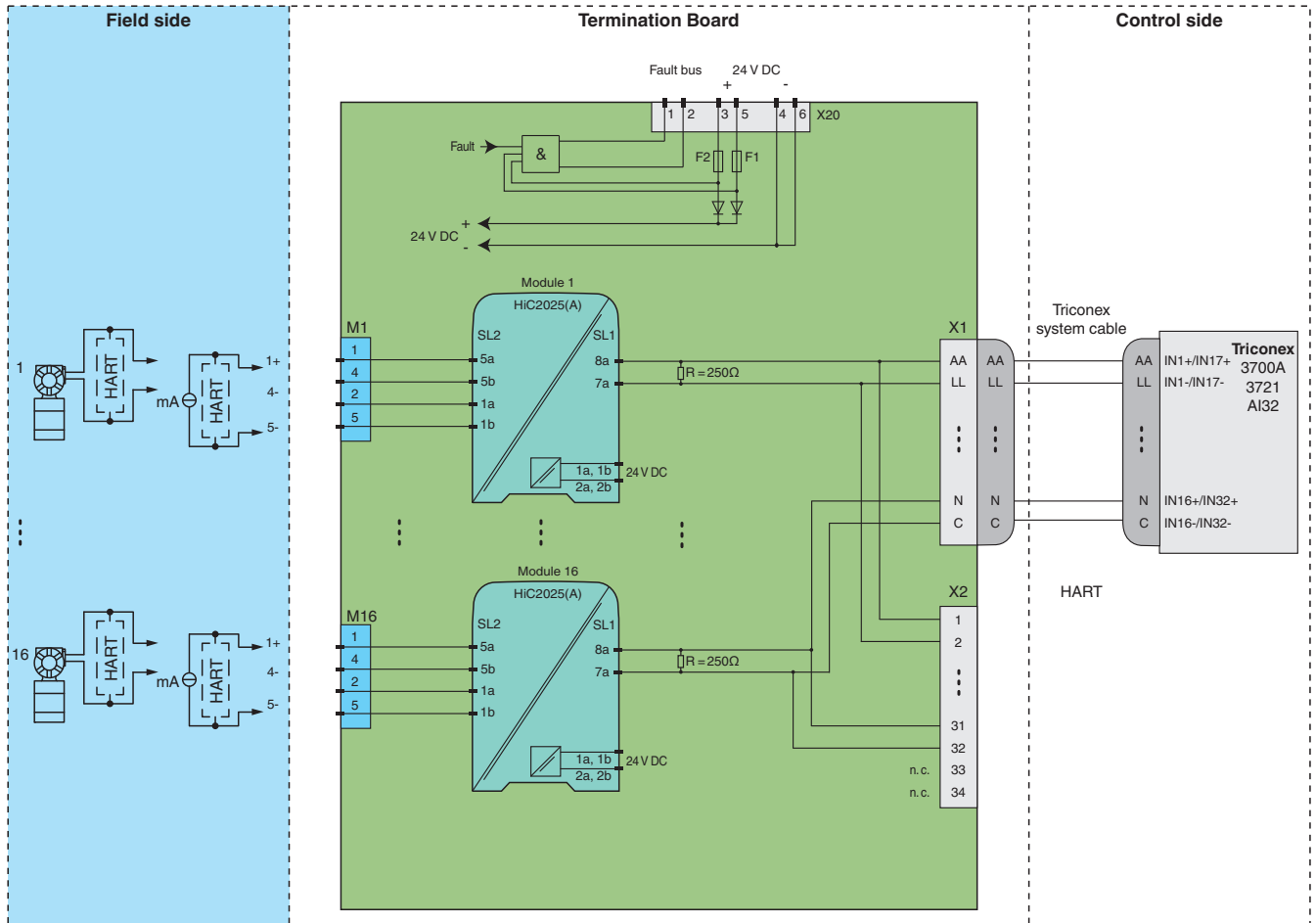

Module switch settings

Type (AI)	DIP switch	Position
HiC2025, HiC2025A (source 4 mA ... 20 mA)	S1	OFF
	S2	OFF
	S3	ON
	S4	OFF

Triconex card setting

0 V DC ... 5 V DC



For exact pin assignment for connection to field side and control side, see the documentation of the isolated barrier.



The pin-out configuration has to be observed. For information see corresponding pin-out table on www.pepperl-fuchs.com.

Release date: 2023-02-20 Date of issue: 2023-02-20 Filename: 215712_eng.pdf