

Termination Board

HiCTB16-HIM-RAC-SP-AO1601

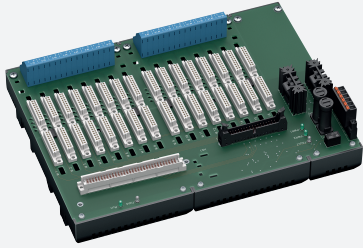

- System board for HIMA, HIMax
- For 16-channel card X-AO 1601 (AO, single mode)
- 16-channel card X-AO 1601 (AO, redundant mode on request)
- For 16 modules
- Recommended module: HiC2031 (AO)
- 24 V DC supply
- Hazardous area: spring terminals, blue
- Non-hazardous area: HIMA system connector, 96-pin



Function

The function of the termination board and the connector pin assignment is exactly fitted to the requirements of the HIMA HIMax system. The signal is output to the safety instrumented system via the system connector. Information about a missing supply voltage of the isolated barriers is available for the system as a volt-free contact. Wiring faults from the field side will be reported via the same relay contact, if this function is supported by the isolated barriers. The termination board has a robust glass fiber reinforced plastic housing. The termination board is mounted in the switch cabinet on a 35 mm DIN mounting rail according to EN 60175.

Connection

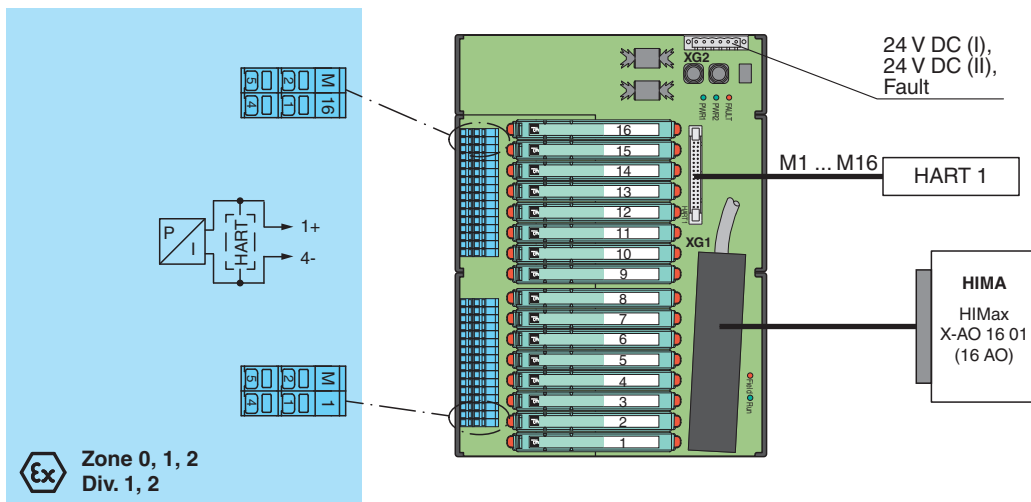

Technical Data

Supply	
Connection	XG2: terminals 1, 3 (+); 2, 4 (-)
Nominal voltage	24 V DC , in consideration of rated voltage of used isolators
Voltage drop	0.9 V , voltage drop across the series diode on the termination board must be considered
Ripple	≤ 10 %
Fusing	4 A , in each case for 16 modules
Power dissipation	≤ 500 mW , without modules
Reverse polarity protection	yes
Redundancy	
Supply	Redundancy available. The supply for the isolators is decoupled, monitored and fused.

Release date: 2023-02-20 Date of issue: 2023-02-20 Filename: 269898_eng.pdf

Refer to "General Notes Relating to Pepperl+Fuchs Product Information".

Pepperl+Fuchs Group
www.pepperl-fuchs.com

USA: +1 330 486 0002
pa-info@us.pepperl-fuchs.com

Germany: +49 621 776 2222
pa-info@de.pepperl-fuchs.com

Singapore: +65 6779 9091
pa-info@sg.pepperl-fuchs.com

PEPPERL+FUCHS

Technical Data









Fault indication output	
Connection	YG2: terminals 5, 6
Output type	volt-free contact
Switch behaviour	no fault: relay contact closed power supply fault: relay contact open module fault: relay contact open
Contact loading	30 V DC, 1 A
Indicators/settings	
Display elements	LED PWR1 (termination board power supply), green LED LED PWR2 (termination board power supply), green LED LED FAULT (fault indication), red LED - LED lits: power supply fault - LED flashes: module fault LED Run, green LED - The HIMax I/O module is supplied with power and is connected to the Termination Board (FTA) via a system cable. LED Field, red LED - The HIMax I/O module detects faults in the connection between HIMax I/O module and Termination Board (FTA).
Directive conformity	
Electromagnetic compatibility	
Directive 2014/30/EU	EN 61326-1:2013 (industrial locations)
Conformity	
Electromagnetic compatibility	NE 21:2017 For further information see system description.
Degree of protection	IEC 60529:2001
Ambient conditions	
Ambient temperature	-20 ... 60 °C (-4 ... 140 °F)
Storage temperature	-40 ... 85 °C (-40 ... 185 °F)
Mechanical specifications	
Degree of protection	IP20
Connection	
Field side	explosion hazardous area: spring terminals , blue
Control side	non-explosion hazardous area: HIMA system connector, 96-pin
Supply	pluggable spring terminals , black
Fault output	pluggable spring terminals , black
Core cross section	spring terminals: 0.25 ... 1.5 mm ² (24 ... 16 AWG)
Material	housing: polycarbonate, 10 % glass fiber reinforced
Mass	approx. 800 g
Dimensions	266 x 200 x 163 mm (10.5 x 7.9 x 6.42 inch) (W x H x D) , depth including module assembly
Mounting	on 35 mm DIN mounting rail acc. to EN 60715:2001
Data for application in connection with hazardous areas	
EU-type examination certificate	CESI 06 ATEX 022
Marking	⊕ II (1)G [Ex ia Ga] IIC ⊕ II (1)D [Ex ia Da] IIIC ⊕ I (M1) [Ex ia Ma] I
Non-hazardous area	
Maximum safe voltage	250 V (Attention! U _m is no rated voltage.)
Galvanic isolation	
Field circuit/control circuit	safe electrical isolation acc. to IEC/EN 60079-11, voltage peak value 375 V
Directive conformity	
Directive 2014/34/EU	EN IEC 60079-0:2018+AC:2020 , EN 60079-11:2012 , EN 50303:2000
International approvals	
UL approval	E106378
Control drawing	116-0327
IECEX approval	
IECEX certificate	IECEX CES 06.0003

Release date: 2023-02-20 Date of issue: 2023-02-20 Filename: 269898_eng.pdf

Technical Data

IECEX marking	[Ex ia Ga] IIC [Ex ia Da] IIC [Ex ia Ma] I
General information	
Supplementary information	Observe the certificates, declarations of conformity, instruction manuals, and manuals where applicable. For information see www.pepperl-fuchs.com .

Accessories

	HiATB01-HART-2X16	HART Communication Board
	HiDMux2700	HART Multiplexer Master
	HiALC-HICTB-SET-108	Label carrier for HiC termination boards
	HiACA-UNI-FLK34-FLK34-0M5	HART Connection Cable, length: 0,5 m
	HiACA-UNI-FLK34-FLK34-1M0	HART Connection Cable, length: 1 m
	HiACA-UNI-FLK34-FLK34-2M0	HART Connection Cable, length: 2 m
	HiACA-UNI-FLK34-FLK34-3M0	HART Connection Cable, length: 3 m
	HiACA-UNI-FLK34-FLK34-6M0	HART Connection Cable, length: 6 m

Application

Typical circuit

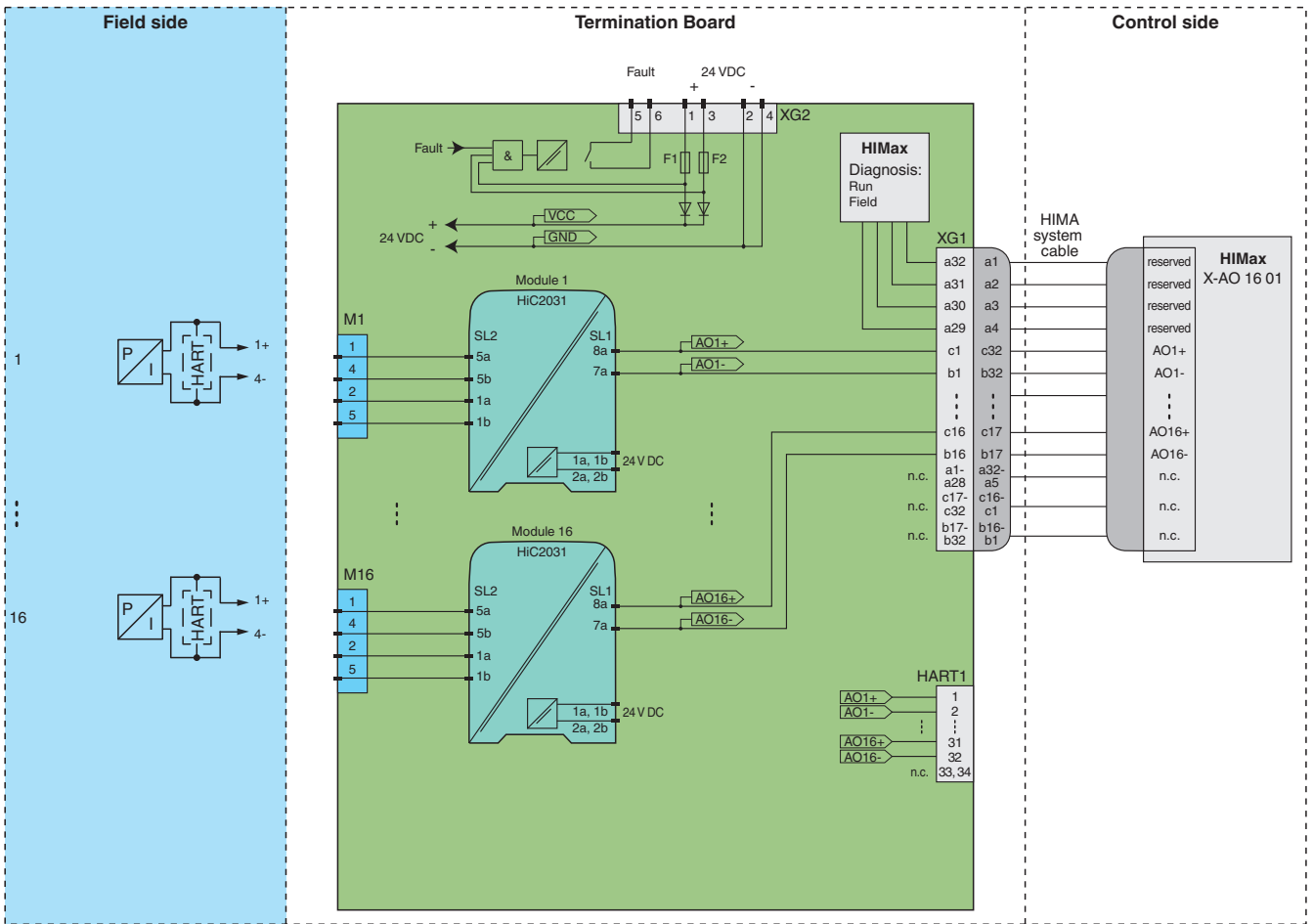

Module switch settings

Type (AO)	
HiC2031	not available

Card settings

Type	Mode
16-channel card X-AO 1601	AO, single mode
	AO, redundant mode on request



For exact pin assignment for connection to field side and control side, see the documentation of the isolated barrier.



The pin-out configuration has to be observed. For information see corresponding pin-out table on www.pepperl-fuchs.com.

Release date: 2023-02-20 Date of issue: 2023-02-20 Filename: 269898_eng.pdf